

RockCast Easy Order Form

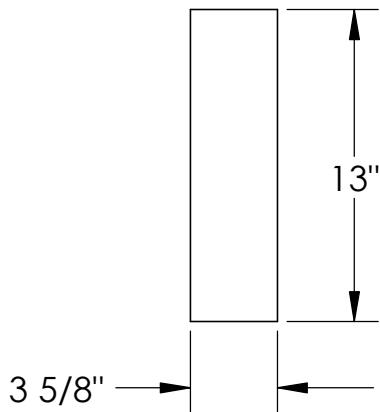

Profile

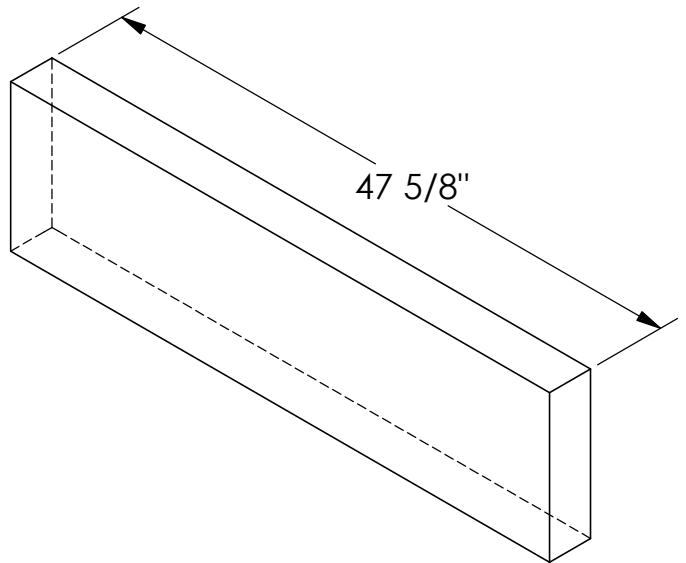

Straight

Qty: ____

176#

SAME AS STRAIGHT PIECE

SAME AS STRAIGHT PIECE

Left Return

Qty: ____

Right Return

Qty: ____

Mold #: BA-102		Buffstone <input type="checkbox"/> Crystal White <input type="checkbox"/> Other <input type="checkbox"/>
RockCast 4600 Devitt Drive Cincinnati, Ohio 45246	Project:	Approved By: