

RockCast Easy Order Form

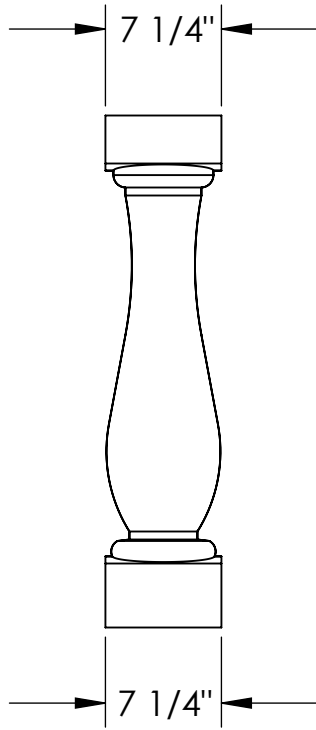

Profile

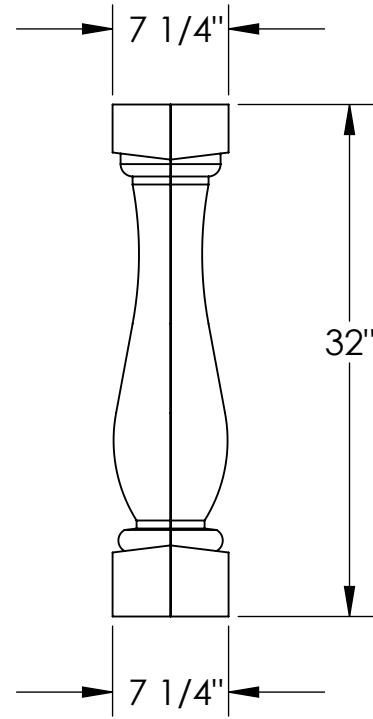

Side

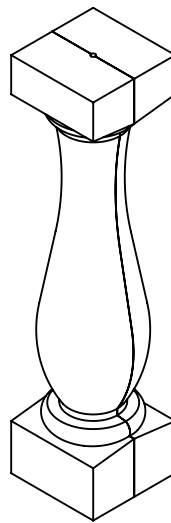

Qty: ____

**BASED ON LOCAL BUILDING CODES AND SPECIFIC USE OF THE RAIL SYSTEM, REBAR MAY BE REQUIRED AND IS AVAILABLE UPON REQUEST

Mold #: BL-2002 ASSEMBLY		Buffstone <input type="checkbox"/> Crystal White <input type="checkbox"/> Other <input type="checkbox"/>
 ROCKCAST 4600 DEVITT DRIVE CINCINNATI, OHIO 45246	Project:	Approved By: