

RockCast Easy Order Form

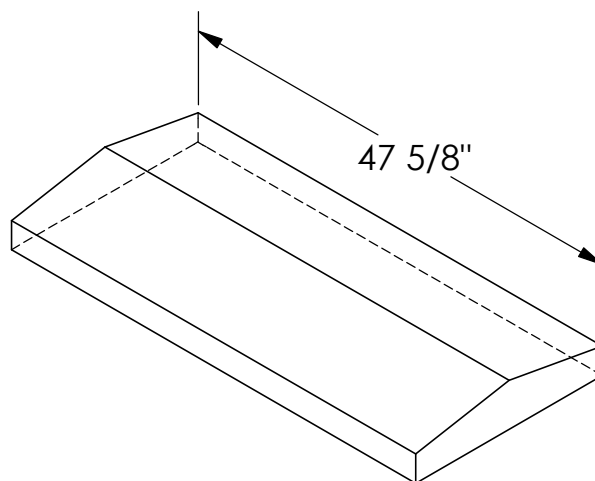
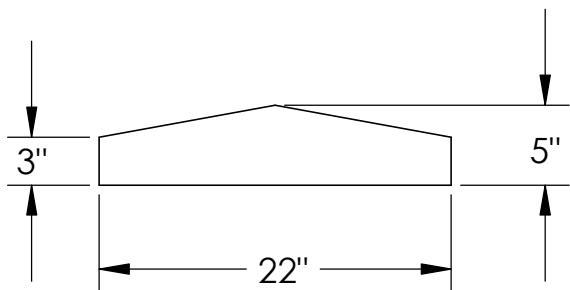

Profile

Straight

Qty: ____

328#

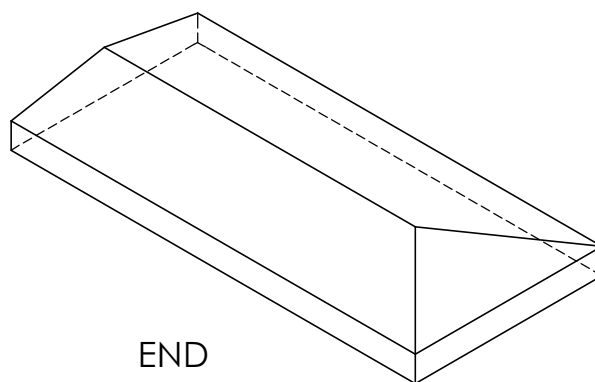

END

Qty: ____

322#

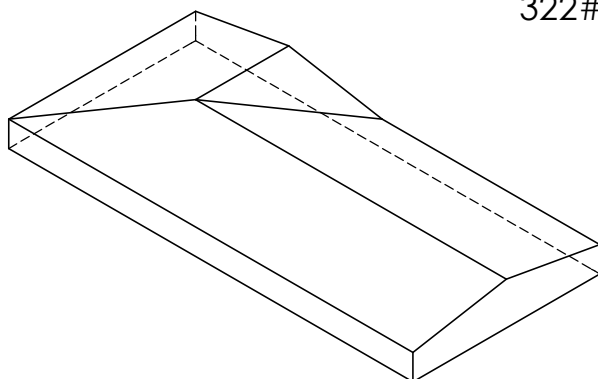

Left Return

Qty: ____

328#

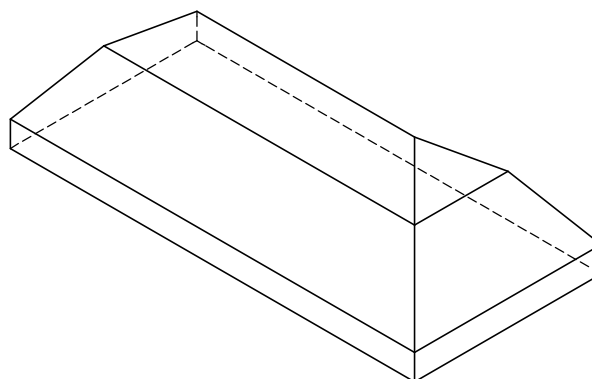

Right Return

Qty: ____

328#

<p>Mold #: CO-222</p>		<p>Buffstone <input type="checkbox"/> Crystal White <input type="checkbox"/> Other <input type="checkbox"/></p>
<p>RockCast 4600 Devitt Drive Cincinnati, Ohio 45246</p>	<p>Project:</p>	<p>Approved By:</p>