

RockCast Easy Order Form

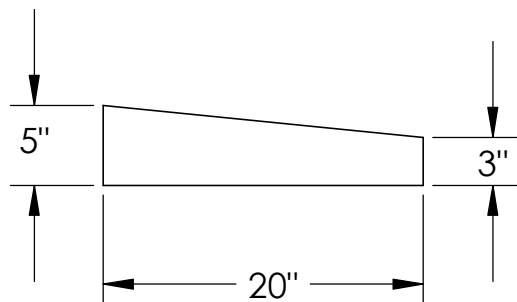

Profile

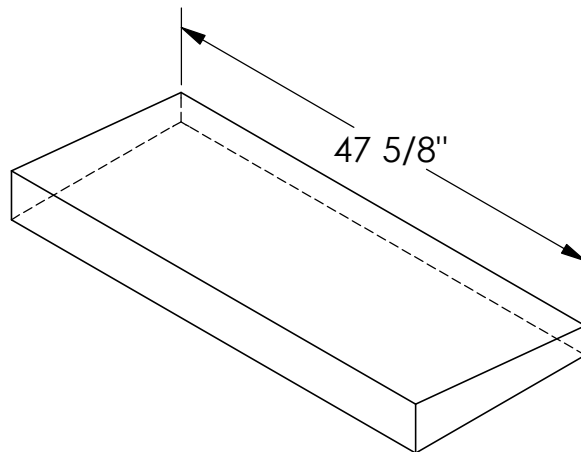

Straight

Qty: ___

299#

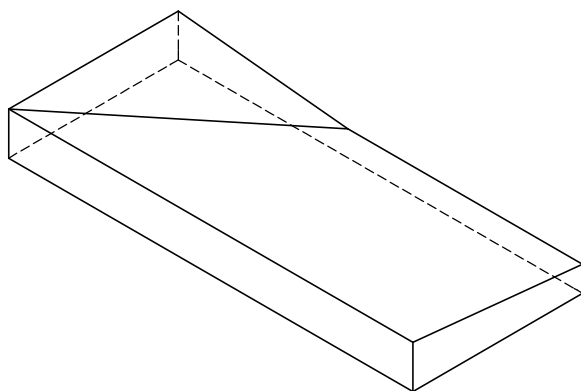

Left Return

Qty: ___

288#

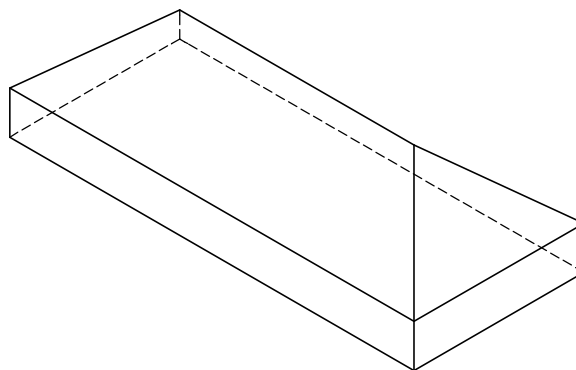

Right Return

Qty: ___

288#

<p>Mold #:</p> <p>CO-420</p>	<p>Rev: 08/05</p>	<p>Buffstone <input type="checkbox"/></p> <p>Crystal White <input type="checkbox"/></p> <p>Other <input type="checkbox"/></p>
<p>RockCast</p> <p>4600 Devitt Drive Cincinnati, Ohio 45246</p>	<p>Project:</p>	<p>Approved By:</p>