

RockCast Easy Order Form

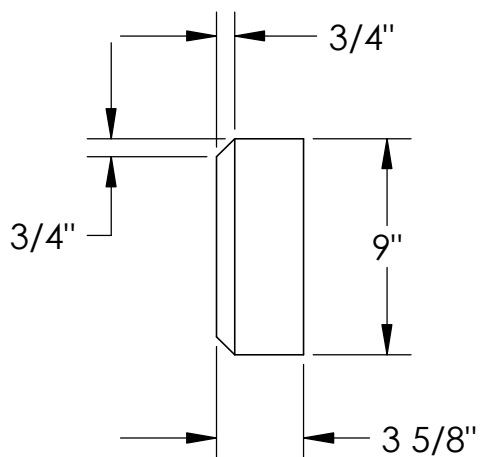

Profile

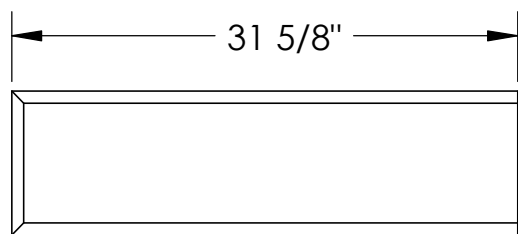

Left Side

Qty: ___

80#

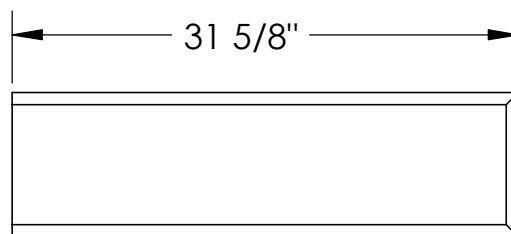

Right Side

Qty: ___

80#

<p>Mold #: HD-2280-A32</p>		<p>Buffstone <input type="checkbox"/> Crystal White <input type="checkbox"/> Other <input type="checkbox"/></p>
<p>RockCast 4600 Devitt Drive Cincinnati, Ohio 45246</p>	<p>Project:</p>	<p>Approved By:</p>