

# RockCast Easy Order Form

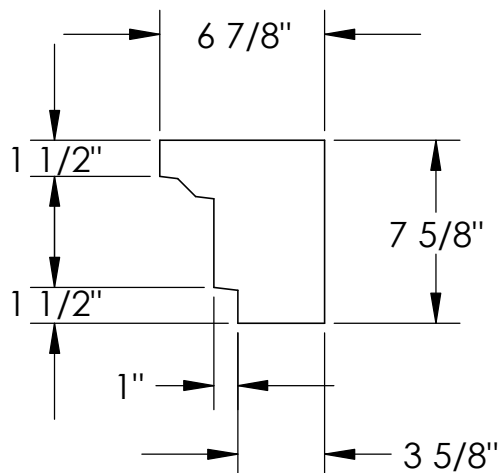

Profile

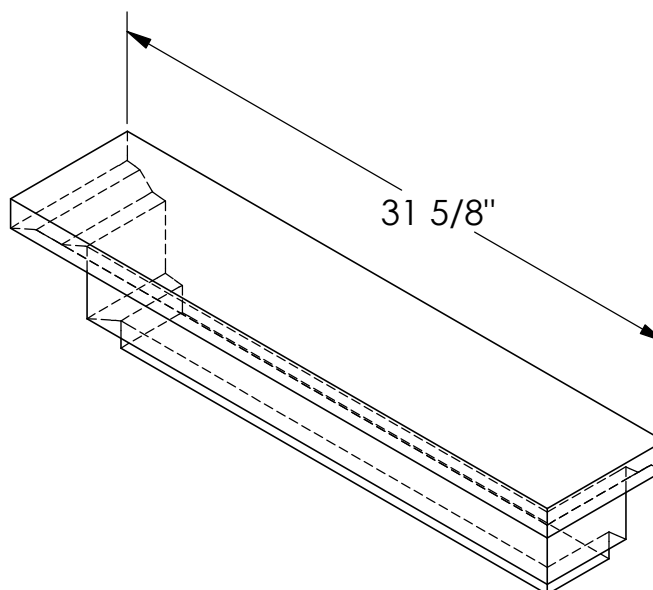

Straight

Qty: \_\_\_\_

86#

Mold #: <b>HD-2301</b>		Buffstone <input type="checkbox"/> Crystal White <input type="checkbox"/> Other <input type="checkbox"/>
<b>RockCast</b> 4600 Devitt Drive Cincinnati, Ohio 45246	Project:	Approved By: