

RockCast Easy Order Form

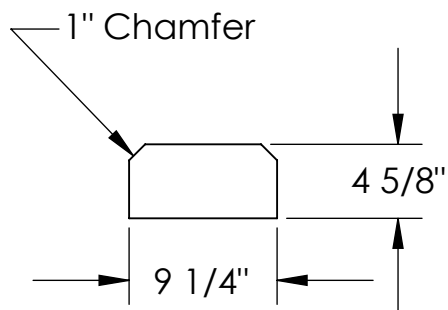

Profile

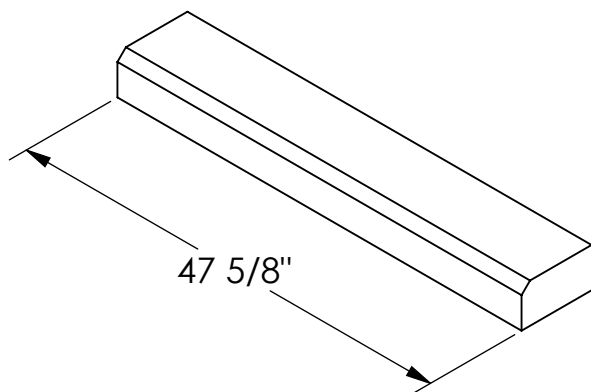

Straight

Qty: ____

Mold #:

MS-2587

Buffstone
Crystal White
Other

 **ROCKCAST**
4600 DEVITT DRIVE
CINCINNATI, OHIO 45246

Project:

Approved By: