

RockCast Easy Order Form

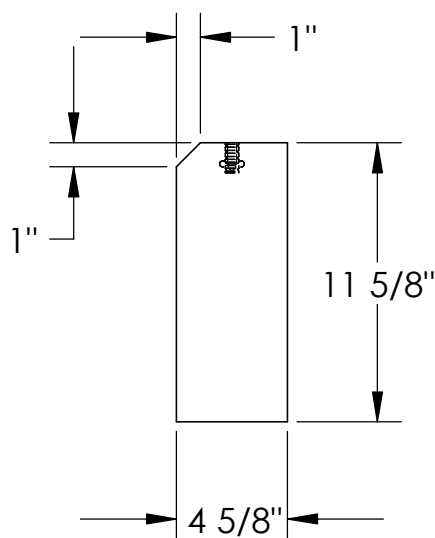

Profile

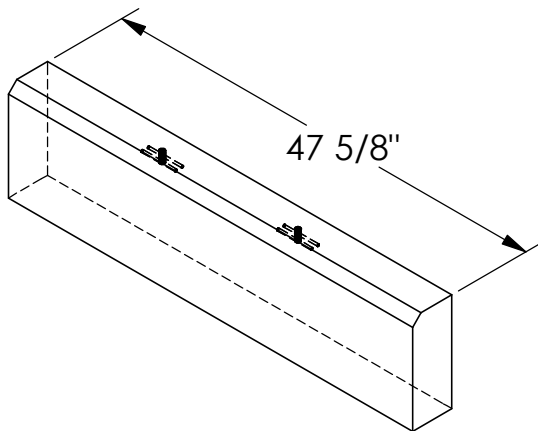

Straight

Qty: ___

199#

PANEL COMES WITH 2 LIFTING INSERTS INSTALLED

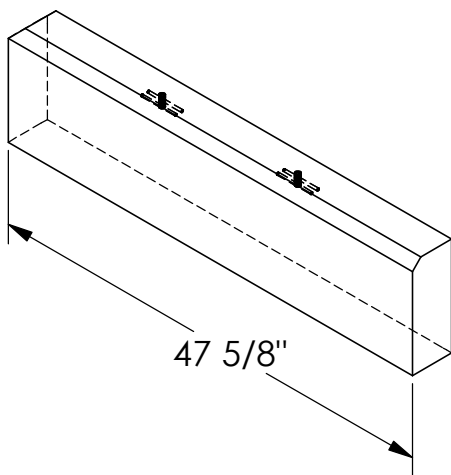

Left Return

Qty: ___

199#

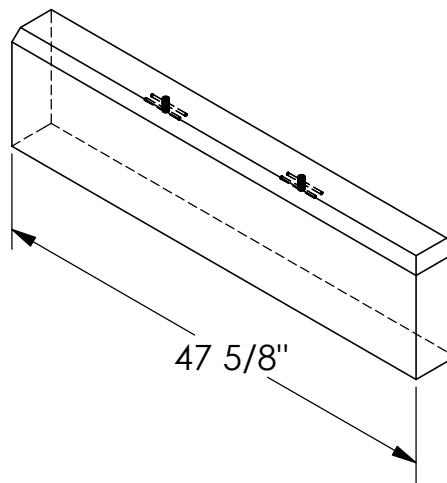

Right Return

Qty: ___

199#

<p>Mold #: PA-2119-48</p>		<p>Buffstone <input type="checkbox"/> Crystal White <input type="checkbox"/> Other <input type="checkbox"/></p>
<p>RockCast 4600 Devitt Drive Cincinnati, Ohio 45246</p>	<p>Project:</p>	<p>Approved By:</p>