

RockCast Easy Order Form

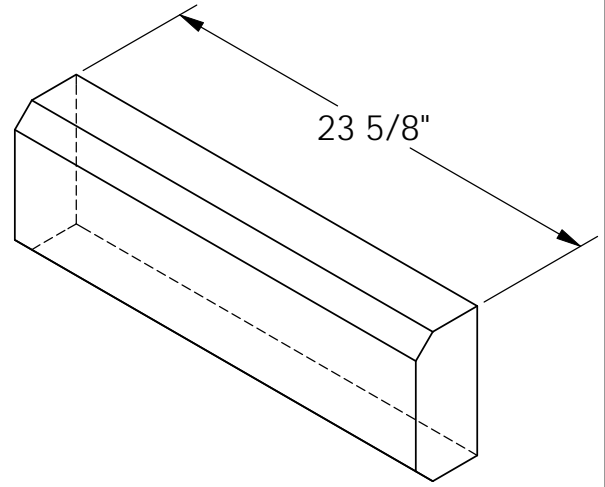
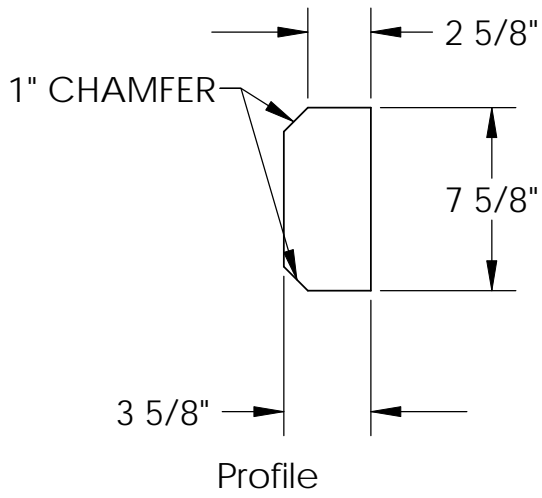

Straight

Qty: ____

Mold #: ST-6054		Buffstone <input type="checkbox"/> Crystal White <input type="checkbox"/> Other <input type="checkbox"/>
 ROCKCAST 4600 DEVITT DRIVE CINCINNATI, OHIO 45246	Project:	Approved By: