

RockCast Easy Order Form

CALIZA

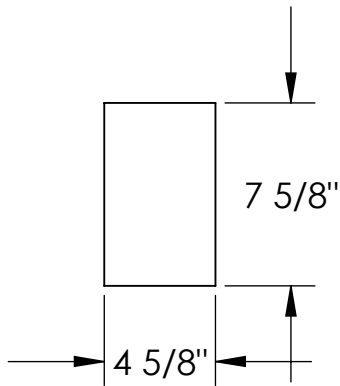

Profile

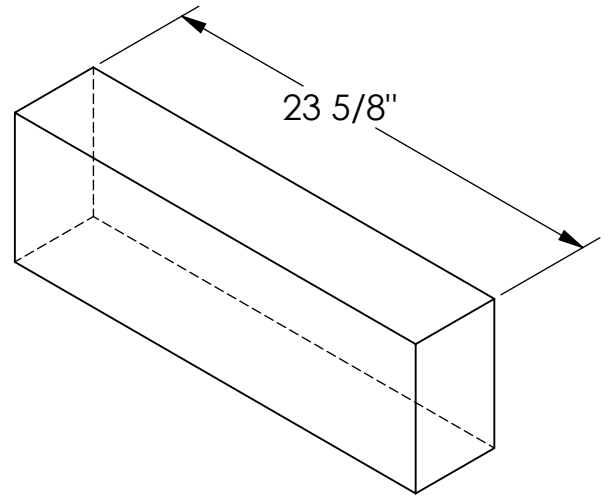

Stretcher

Qty: ____

Mold #: CTST-025		Color: (Please Specify)
RockCast 4600 Devitt Drive Cincinnati, Ohio 45246	Project:	Approved By: