

RockCast Easy Order Form

CALIZA

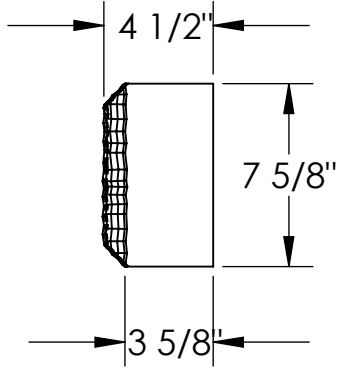

Profile

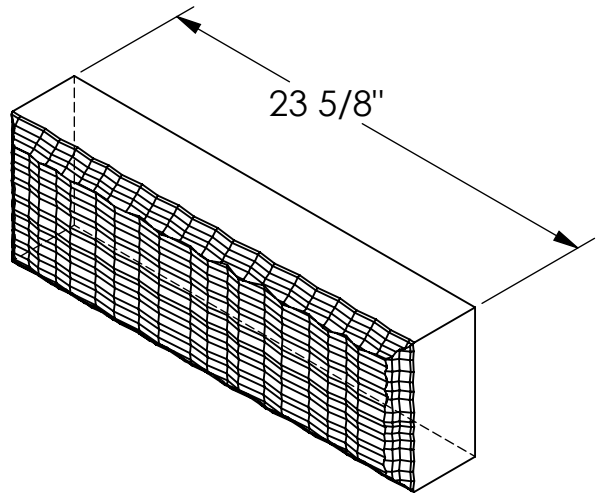

Chiseled Stretcher

Qty: ____

Mold #:

CTST-205

Color: (Please Specify)

RockCast

4600 Devitt Drive
Cincinnati, Ohio 45246

Project:

Approved By: