

RockCast Easy Order Form

CALIZA

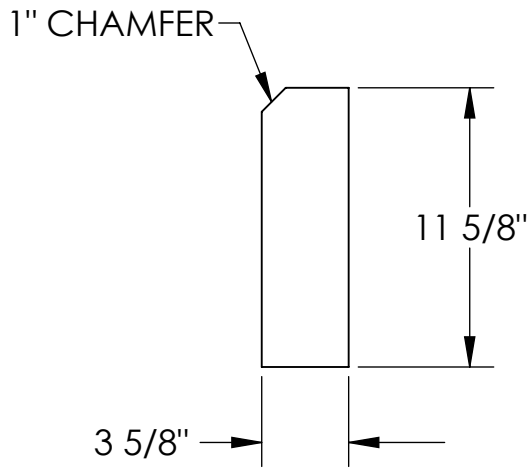

Profile

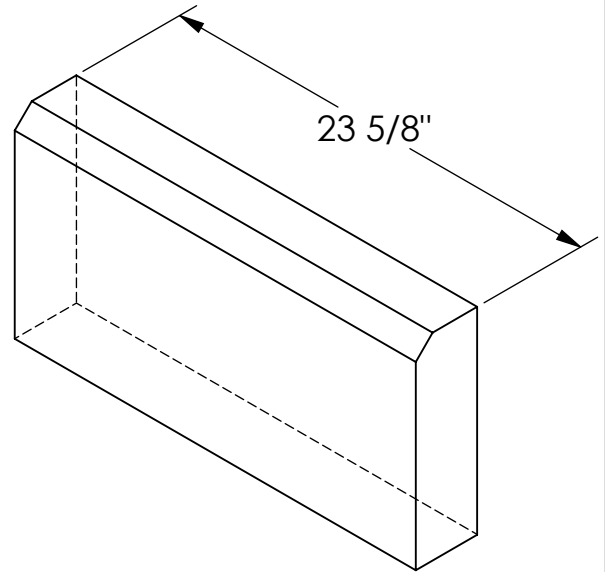

Straight

Qty: ____

Mold #:

CTST-5034

Color: (Please Specify)

 **ROCKCAST**
4600 DEVITT DRIVE
CINCINNATI, OHIO 45246

Project:

Approved By: