

RockCast Easy Order Form

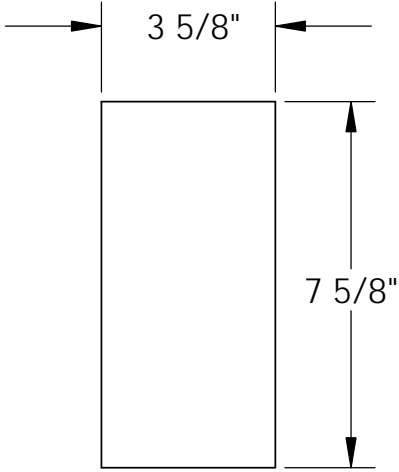

Profile

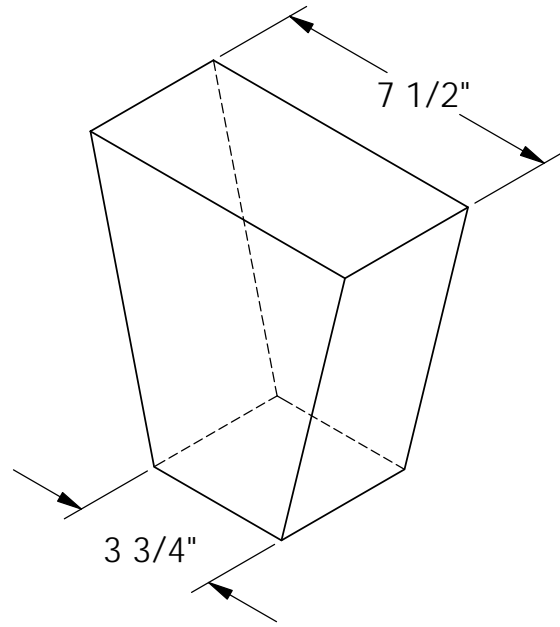

Keystone

Qty: ____

Mold #: KY-300		Buffstone <input type="checkbox"/> Crystal White <input type="checkbox"/> Other <input type="checkbox"/>
 ROCKCAST 4600 DEVITT DRIVE CINCINNATI, OHIO 45246	Project:	Approved By: