

# RockCast Easy Order Form

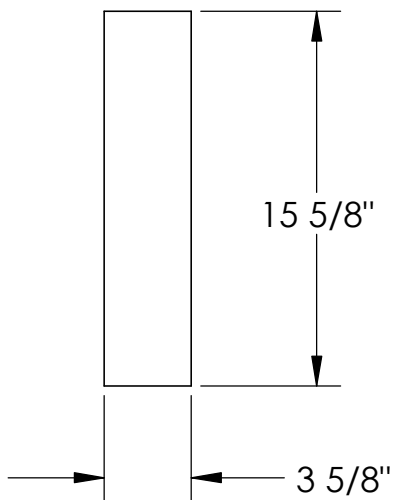

Profile

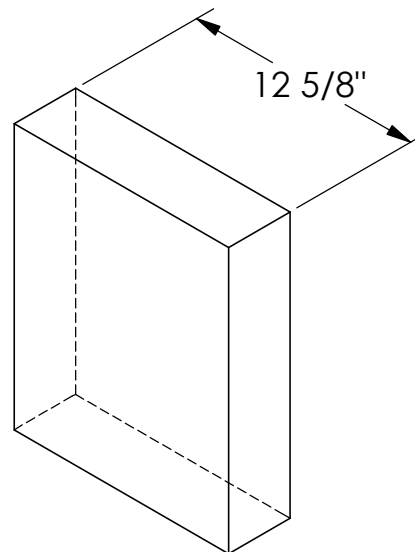

Quoin

Qty: \_\_\_\_

Mold #: <b>QM-520</b>		Buffstone <input type="checkbox"/> Crystal White <input type="checkbox"/> Other <input type="checkbox"/>
<b>RockCast</b> 4600 Devitt Drive Cincinnati, Ohio 45246	Project:	Approved By: