

RockCast Easy Order Form

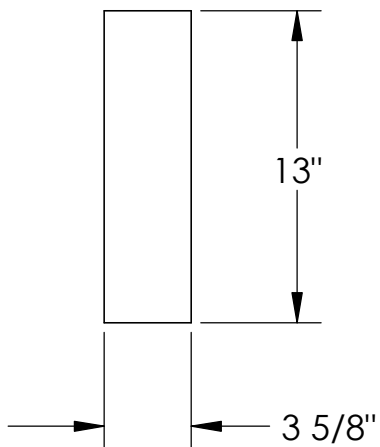

Profile

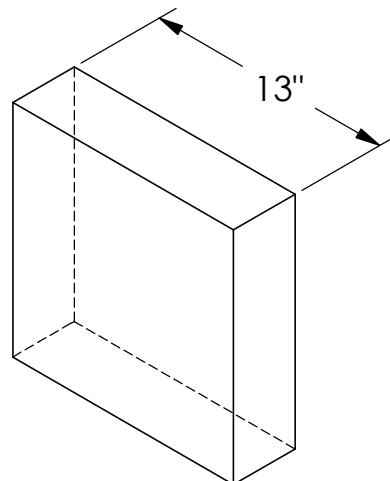

Quoin

Qty: ____

Mold #: QM-740		Buffstone <input type="checkbox"/> Crystal White <input type="checkbox"/> Other <input type="checkbox"/>
RockCast 4600 Devitt Drive Cincinnati, Ohio 45246	Project:	Approved By: