

RockCast Easy Order Form

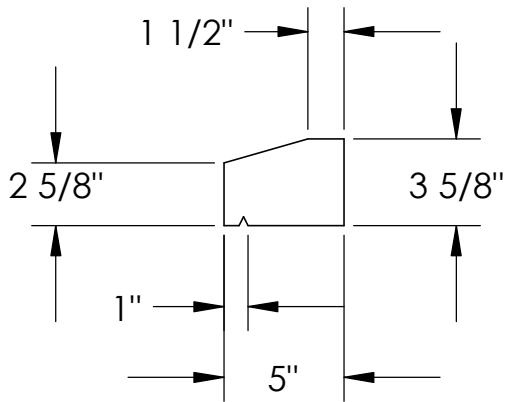

Profile

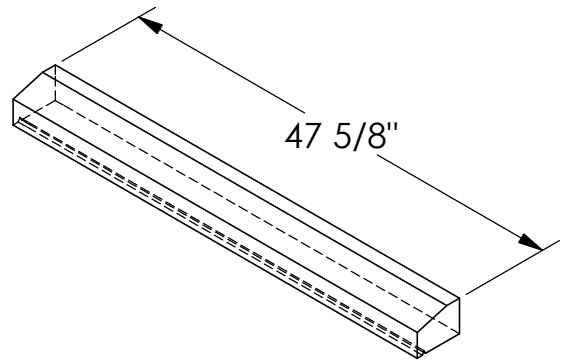

Straight

Qty: ___

61#

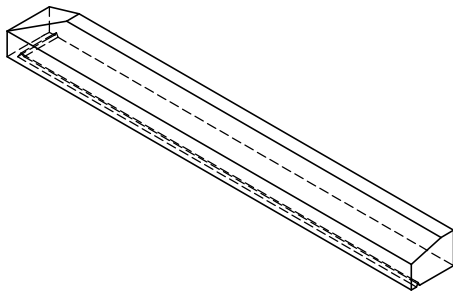

Left Return

Qty: ___

61#

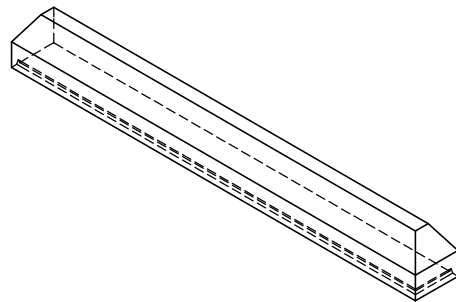

Right Return

Qty: ___

61#

Mold #: SL-100		Buffstone <input type="checkbox"/> Crystal White <input type="checkbox"/> Other <input type="checkbox"/>
RockCast 4600 Devitt Drive Cincinnati, Ohio 45246	Project:	Approved By: