

# RockCast Easy Order Form

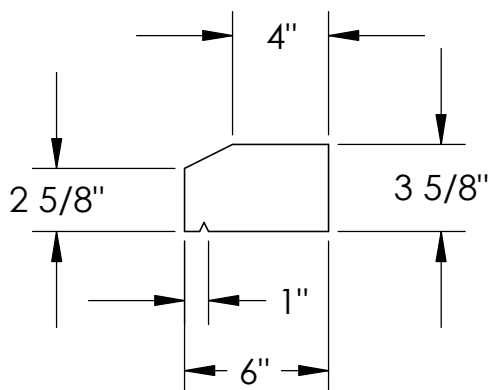

Profile

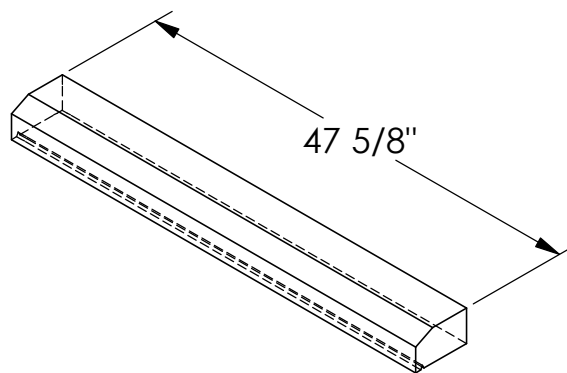

Straight

Qty: \_\_\_

77#

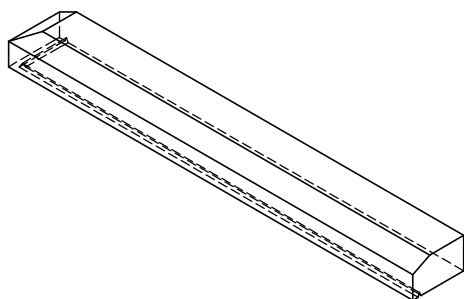

Left Return

Qty: \_\_\_

77#

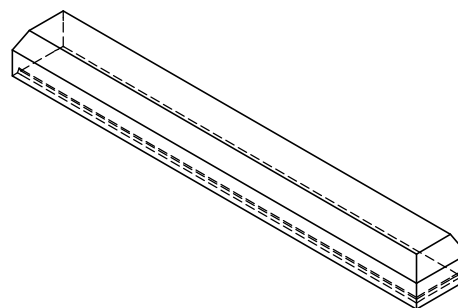

Right Return

Qty: \_\_\_

77#

<p>Mold #: <b>SL-325</b></p>		<p>Buffstone <input type="checkbox"/>                  Crystal White <input type="checkbox"/>                  Other <input type="checkbox"/></p>
<p><b>RockCast</b>                  4600 Devitt Drive                  Cincinnati, Ohio 45246</p>	<p>Project:</p>	<p>Approved By:</p>